

PLUS - Static Preparation 2000 mm Passthrough Hot Cupboard

ITEM # _____

MODEL # _____

NAME # _____

SIS # _____

AIA # _____

134058 (GTCD2000E)

 Pass-through hot Cupboard,
with 1 shelf and 4 sliding
doors, 2000mm

Short Form Specification

Item No.

Enhanced stability and solid construction thanks to the welded frame and legs and ventilated hot air flow system guarantees temperature evenness. Model specific to keep dishes warm. Can reach a maximum temperature of 70° in 45 minutes. The 50mm high worktop in 304 AISI stainless steel, with Scotch Brite finishing 15/10 mm in thickness, has anti-drip edges and welded corners. 18mm thick undertop waterproof reinforcement, it's completely waterproof, double-sided laminated and 100% recyclable. Sound-deadened double walled sliding doors on roll bearings with end limit stop (7/10 in thickness in 304 AISI stainless steel). Equipped with 40mm high hot intermediate shelf (8/10 in thickness) in 304 AISI stainless steel with upturned edges and AISI 304 bar reinforcement. Base panel in AISI 304 stainless steel (8/10 in thickness) with upturned edges reinforced by stainless steel AISI 304 bars. Welded to the legs for further structure reinforcement. Height adjustable feet (-20/+30 mm) in 304 AISI stainless steel.

Main Features

- Enhanced stability and solid construction. Stability, loading and stress tests by external certified body.
- Product range suitable for international tenders requirements for intense usage installations.
- Suitable to keep dishes warm up to an adjustable max temperature of 70°C (ventilated heating).
- 2h approximately warming time. Depending on dishes shape and dimension, warming time can vary.

Construction

- Welded frame and legs.
- Worktop with 50 mm high profile, in s/s Scotch Brite finishing, 15/10 in thickness with anti-drip edges and welded corners.
- Constructed entirely in 304 AISI stainless steel.
- Undertop is 18mm in thickness, reinforced, completely waterproof, double-sided laminated and 100% recyclable.
- Door sliding system is fluent and reliable, tested with over 80.000 cycles by external certified body.
- Sliding doors are in stainless steel and double-walled with sound-deadening material inside. They are 7/10mm in thickness with roll bearings and end limit stop.
- Cupboard interior has easy access thanks to completely openable doors.
- Intermediate shelf has 40mm high profile, is 8/10 in thickness with upturned edges and bar reinforcement. It can be positioned at three different heights.
- Base panel has 40mm high profile, is 8/10 in thickness with upturned edges and bar reinforcement. It is welded to legs for further structure reinforcement.
- Height-adjustable stainless steel feet (-20/+30mm).

Optional Accessories

- Set of 4 wheels (2 with brake), PNC 855207 □ diameter=125mm

APPROVAL: _____

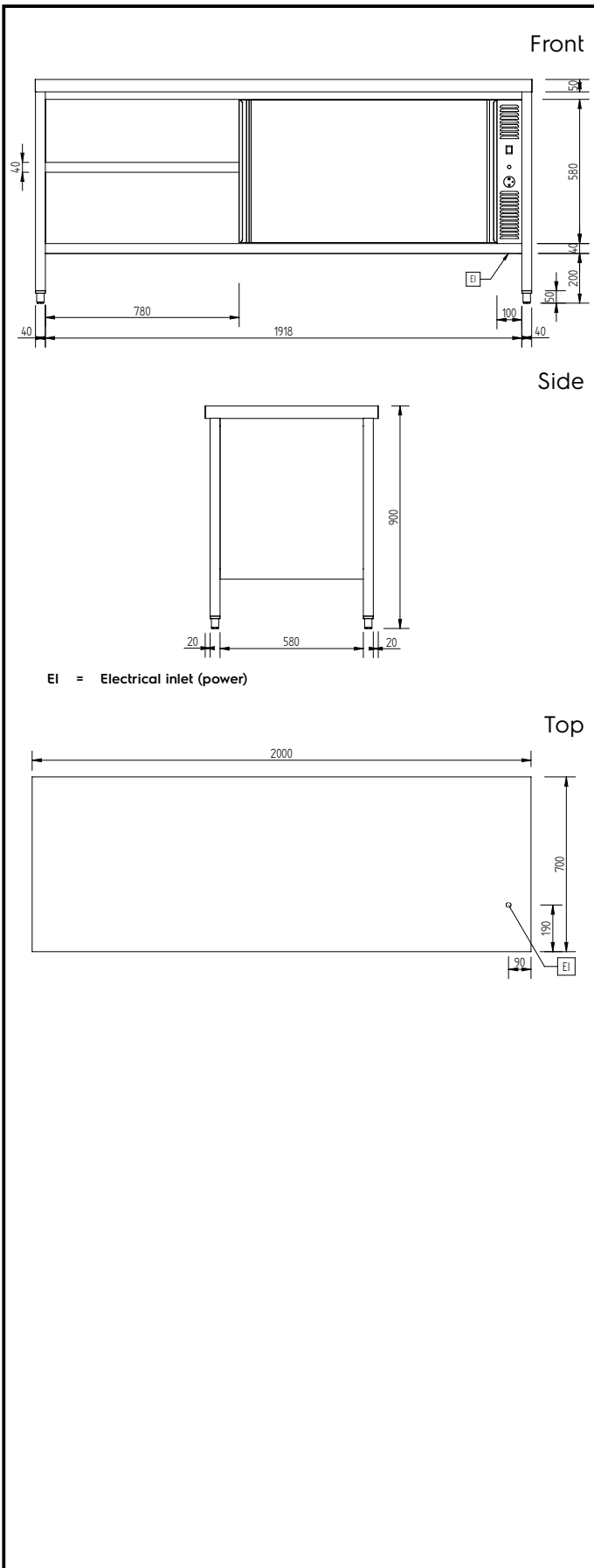

Electric

Supply voltage:	220-240 V/1N ph/50/60 Hz
Total Watts:	2.53 kW

Key Information:

Adjustable Feet	-20/+30 mm
Cabinet width:	1918 mm
Cabinet depth:	580 mm
Cabinet height:	580 mm
Cabinet temperature:	+30/+90 °C
External dimensions, Width:	2000 mm
External dimensions, Depth:	700 mm
External dimensions, Height:	900 mm
Number and type of doors:	4 Sliding
Worktop thickness:	50 mm
Net weight:	116 kg